

# GAIA

## Installation manual

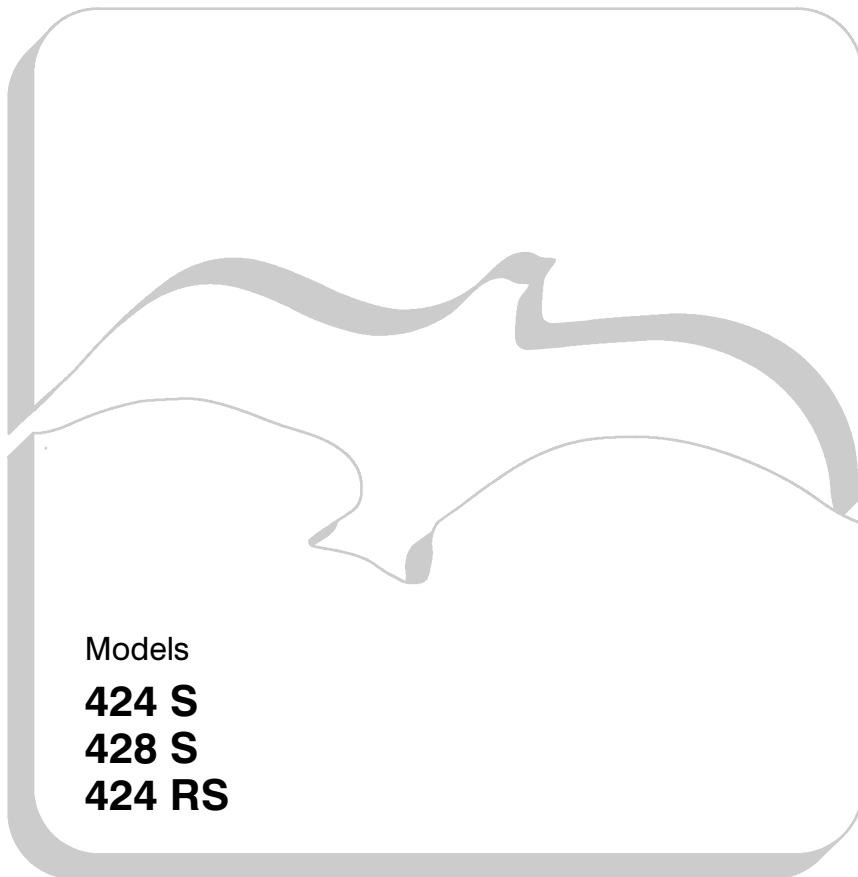

Models

**424 S**

**428 S**

**424 RS**





## Boiler installation and commissioning tips



- ✔ Do not forget to remove the transit caps and plugs from the boiler connections these are fitted to every boiler.
- ✔ Keep the boiler clear of dust during installation and in particular do not allow any dust or debris to enter the top of the boiler where the flue connection is made. It is recommended that you put a dust sheet over the top of the boiler until you are ready to make the flue connection.
- ✔ Because every boiler is fired and tested live at the factory, a small amount of water remains within the boiler. It is possible for this water to initially cause the pump to seize. It is therefore recommended that the pump rotor be manually turned to free its rotation before turning the boiler on.
- ✔ Remember to release the auto air purge before filling the boiler. See the instructions to identify the location of this device.
- ✔ Do not remove the cap of the pressure test point of the air switch (top right side of the boiler).
- ✔ You are strongly advised to flush out the system both cold and hot in order to remove system and installation debris.
- ✔ It is also sensible to initially fire and commission the boiler before connecting any external controls such as a room thermostat. By this method if you have a subsequent problem following the addition of an external control you can eliminate the boiler from your fault analysis.
- ✔ Do not forget to range rate the boiler to suit the system requirements. This procedure is covered in the commissioning section of the installation manual.
- ✔ If the boiler is fitted with a digital programmer, when setting the times for automatic operation, remember that for every “ON” time there must be an “OFF” time to follow and that on every occasion you enter a time you must also indicate which days that you want the boiler to follow the timed settings.
- ✔ Some products incorporate an anti cycling time delay. It is normal when first switching the boiler on for the boiler to operate on heating for a few seconds then switch off. After 3–4 minutes has elapsed the boiler will then re ignite and operate perfectly normally. The ignition delay cycle does not prevent normal operation of the boiler to provide domestic hot water.
- ✔ If you are in any doubts as to the installation or operation of the boiler please read the instruction manuals thoroughly and then if necessary contact Biasi UK for advice and assistance.

# Important

## **The manual...**

must be read thoroughly, so that you will be able to use the boiler in a safe and sensible way;

must be carefully kept. It may be necessary for reference in the future.

## **Installation...**

must be carried out by a qualified person who will be responsible for observing the current Regulations.

## **First lighting up...**

must be carried out by a competent and responsible person; the guarantee is valid from the date it is carried out.

## **Repairs...**

(under guarantee)

must be carried out only by a competent and responsible person, using genuine spare parts. Thus do no more than switching off the boiler yourself (see the instructions).

## **Your boiler...**

allows heating up of water to a temperature less than the boiling point;

must be connected to a central heating system and/or a hot water supply system, compatible with its performance and output;

can be used only for those purposes for which it has been specially designed;

must not be touched by children or by those unfamiliar with its operation;

must not be exposed to the elements.

## **The manufacturer...**

disclaim all liability for any translations of the present manual from which incorrect interpretation may occur;

accepts no responsibility for unsatisfactory performance of the appliance and flue due to failure to comply the following instructions.

# TABLE OF CONTENTS

<b>1</b>	<b>General</b> .....	<b>2</b>	<b>4</b>	<b>Commissioning</b> .....	<b>20</b>
1.1	Overview .....	2	4.1	Electrical installation .....	20
1.2	Control panel .....	3	4.2	Gas supply installation .....	20
1.3	Main diagram 424 S, 428 S .....	4	4.3	Filling the D.H.W. system .....	20
1.4	Main diagram 424 RS .....	5	4.4	Initial filling of the system .....	20
			4.5	Lighting the boiler .....	21
			4.6	Checking the gas pressure at the burner .....	21
<b>2</b>	<b>General requirements</b> .....	<b>13</b>	4.7	Checking the flue system .....	22
1.5	Technical data mod. 424 S .....	6	4.8	Checking the ignition device .....	22
1.6	Technical data mod. 428 S .....	8	4.9	Adjusting the burner ignition .....	22
1.7	Technical data mod. 424 RS .....	10	4.10	Adj. of useful c.h. heating output ..	23
1.8	Hydraulic specifications .....	12	4.11	Instructing the user .....	24
1.9	Expansion tank .....	12			
2.1	Related documents .....	13	<b>5</b>	<b>Gas conversion</b> .....	<b>25</b>
2.2	Location of appliance .....	13	5.1	Warnings .....	25
2.3	Flue system .....	13	5.2	Procedures .....	25
2.4	Gas supply .....	13	<b>6</b>	<b>Maintenance</b> .....	<b>26</b>
2.5	Air supply .....	14	6.1	Warnings .....	26
2.6	Ventilation .....	14	6.2	Dismantling the external panels ..	26
2.7	Water circulation (central heating) ..	14	6.3	Emptying the d.h.w. system (Combination boilers only) .....	26
2.8	Domestic water .....	15	6.4	Emptying the c.h. system .....	26
2.9	Electrical supply .....	15	6.5	Cleaning the primary heat exchanger	27
			6.6	Checking the pressurisation in the expansion tank .....	27
<b>3</b>	<b>Installation</b> .....	<b>16</b>	6.7	Cleaning the burner .....	27
3.1	Warnings .....	16	6.8	Checking the exhaust duct .....	27
3.2	Precautions .....	16			
3.3	Installing the bracket .....	17			
3.4	Mounting the boiler .....	17			
3.5	Fitting the balanced flue system ..	17			
3.6	Electrical connections .....	18			
3.7	Frost protection (froststat) .....	19			
3.8	Overall dimensions .....	19			
3.9	Joints .....	19			

## Symbols used in the descriptions:

**Combi** = 424 S, 428 S

**24** = 424 S, 424 RS

**Central heating** = 424 RS

**28** = 428 S

This appliance complies with the EEC directive 90/396 and, therefore, the use of the



mark is allowed.

It also complies with the EEC directive 87/308 relative to the prevention and elimination of radio interference.

This appliance is made in accordance with current European standards regarding the safety of gas appliances and safety in using electrical household appliances.

The manufacturer, in his continuous search to improve his products, reserves the right to modify the data given herein without prior notice.

This documentation is for information purposes only and is not to be considered a contract.

# 1 GENERAL

## 1.1 Overview

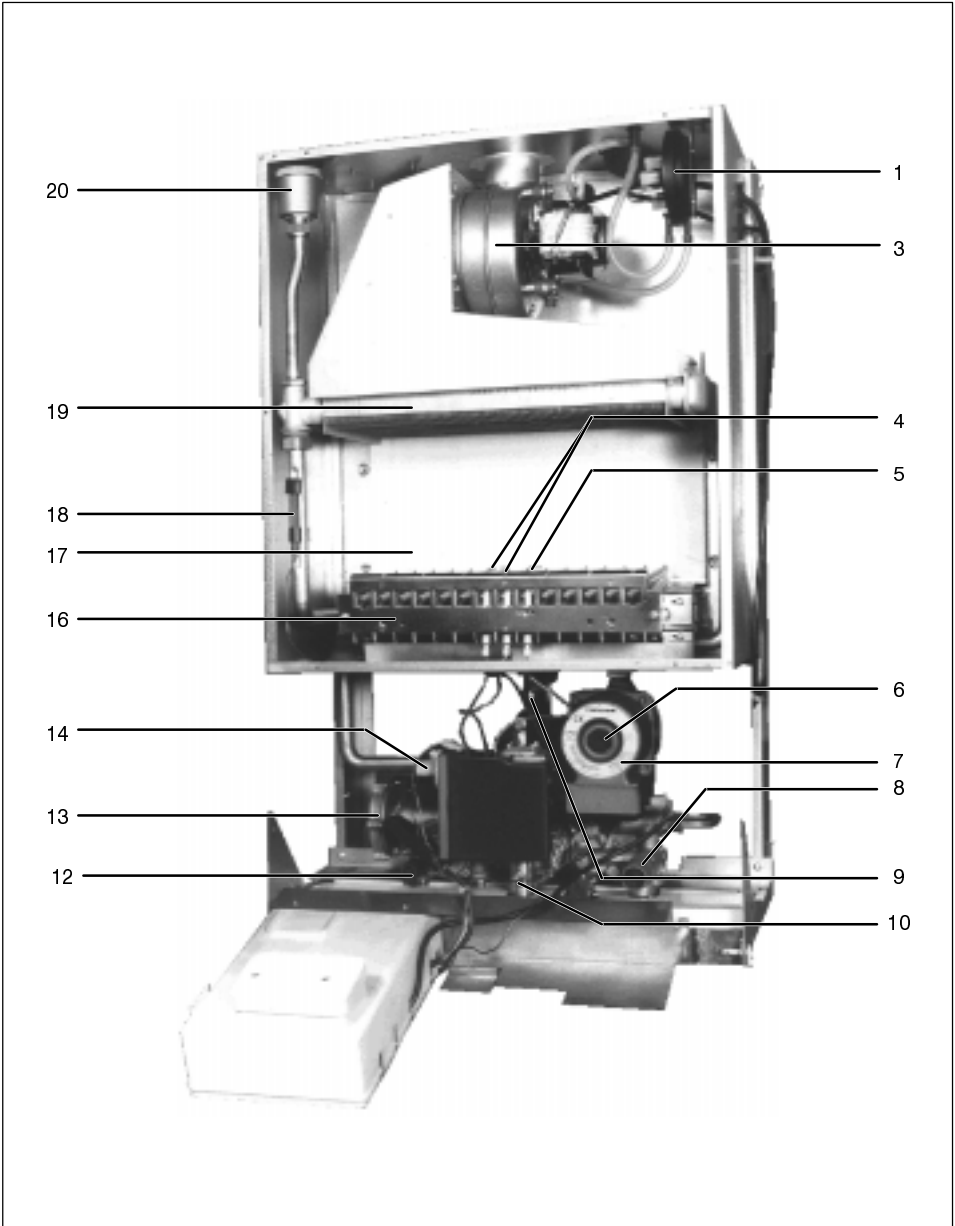

fig. 1.1

---

## General

---

- 1 Air pressure switch
- 2 Venturi device
- 3 Fan
- 4 Ignition electrode
- 5 Flame detection electrode
- 6 Pump vent plug
- 7 Pump
- 8 3 bar pressure relief valve
- 9 Gas valve outlet pressure test point
- 10 Gas valve inlet pressure test point
- 11 Modulation gas valve
- 12 Main circuit drain valve
- 13 Three-way diverter valve
- 14 Modulation operator
- 15 Three-way diverter valve body
- 16 Burner
- 17 Combustion chamber
- 18 Safety thermostat (probe)
- 19 Primary heat exchanger
- 20 Automatic bleed valve
- 21 Domestic hot water flow switch
- 22 Central heating flow switch
- 23 Domestic hot water probe NTC
- 24 Central heating probe NTC
- 25 Domestic hot water heat exchanger
- 26 By-pass
- 27 Expansion tank
- 28 Central heating return cock
- 29 Domestic cold water inlet cock
- 30 Gas cock

- 31 Domestic hot water outlet pipe
- 32 Central heating flow cock
- 33 Flue outlet pipe
- 34 Air intake pipe

### 1.2 Control panel

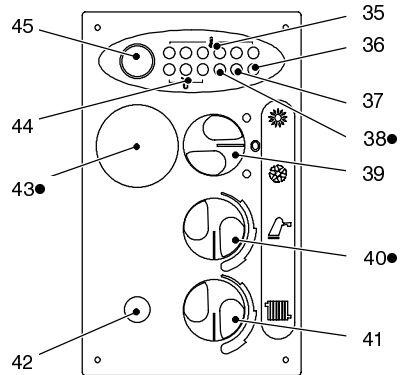

fig. 1.2

- 35 Main circuit temperature display
- 36 "Appliance ON" light
- 37 "Heat request" light
- 38 Domestic hot water operation light ●
- 39 Function switch
- 40 D.h.w. temperature adjustment knob ●
- 41 Central heating temperature adjustment knob
- 42 Safety thermostat reset button
- 43 Time switch (central heating control) ●
- 44 Main circuit pressure display
- 45 Lock-out signal lamp and reset button

**1.3 Main diagram 424 S, 428 S**

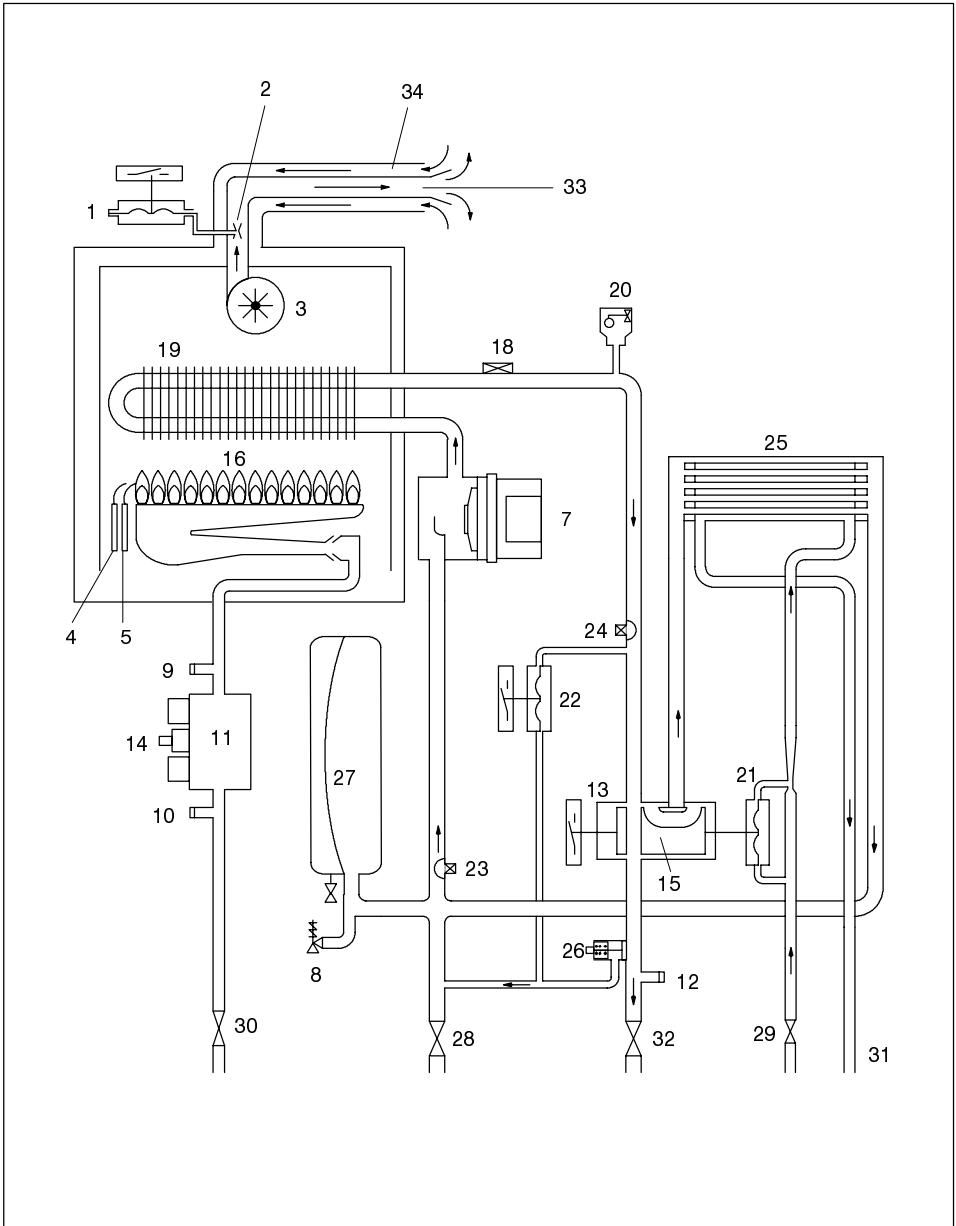

fig. 1.3 (key on page 3)



**1.4 Main diagram 424 RS**

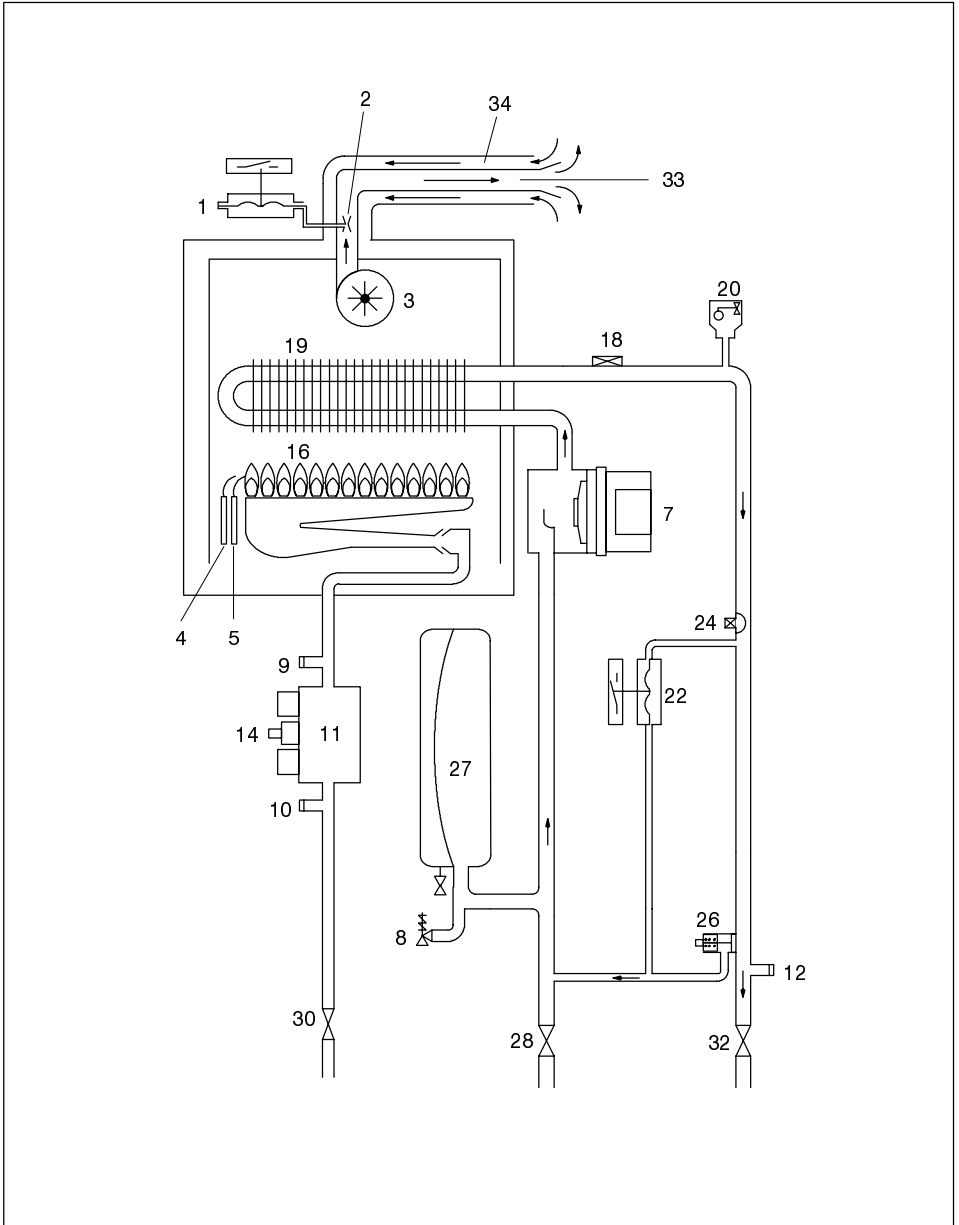

fig. 1.4 (key on page 3)

## General

### 1.5 Technical data mod. 424 S

Nominal heat input	kW	26,6
	BTU/h	90 754
Minimum heat input	kW	11,0
	BTU/h	37 530
Maximum useful output	kW	24,0
	BTU/h	81 883
Minimum useful output	kW	9,3
	BTU/h	31 730

Central heating		
Maximum temperature	°C	90
Minimum temperature	°C	35
Maximum pressure	kPa	300
	bar	3
Minimum pressure	kPa	30
	bar	0,3
Available head (in 1000 l/h)	kPa	26
	bar	0,26

Domestic hot water		
Maximum temperature	°C	55
Minimum temperature	°C	37
Maximum pressure	kPa	1 000
	bar	10
Minimum pressure	kPa	30
	bar	0,3
Flow rate		
minimum	l/min	2,5
30° rise	l/min	11,1
35° rise	l/min	9,5
40° rise	l/min	8,3

Injectors	
Natural G20	125
Butane G30	75
Propane G31	75

Gas supply pressures				
Gas		norm.	min	max
Natural G20	Pa	2 000	1 700	2 500
	mbar	20	17	25
Butane G30	Pa	2 900	2 000	3 500
	mbar	29	20	35
Propane G31	Pa	3 700	2 500	4 500
	mbar	37	25	45

Maximum gas pressures at the burner		
Natural G20	Pa	1 050
	mbar	10,5
Butane G30	Pa	2 680
	mbar	26,8
Propane G31	Pa	3 500
	mbar	35,0
Maximum gas rate		
Natural G20	m <sup>3</sup> /h	2,82
Butane G30	kg/h	2,09
Propane G31	kg/h	2,06

Minimum gas pressures at the burner		
Natural G20	Pa	130
	mbar	1,3
Butane G30	Pa	550
	mbar	5,5
Propane G31	Pa	700
	mbar	7,0
Minimum gas rate		
Natural G20	m <sup>3</sup> /h	1,16
Butane G30	kg/h	0,87
Propane G31	kg/h	0,85

G 20 p.c.i. 35,9 MJ/m<sup>3</sup>

G 30 p.c.i. 45,6 MJ/kg

G 31 p.c.i. 46,4 MJ/kg

1 mbar approximately equals 10 mm H<sub>2</sub>O

---

## General

---

<b>Electrical Data</b>		
Voltage	V~	220–240
Frequency	Hz	50
Power consumption	W	170
Protection degree		IP44
External fuse rating	A	3
Internal fuse rating	A	1,6 T

<b>Flue design</b>		
Minimum venturi pressure	mbar	–1,2
Flue pipe diameter		
Coaxial	mm	60/100
Twin split pipes	mm	80
Roof	mm	80/120
Nominal heat flow rate*	kW	26,6
Exhaust temperature*	°C	125
Smoke production*	kg/h	70
<i>* Values refer to tests with a 1 m chimney working at the nominal heat input</i>		

<b>Other specifications</b>		
Height	mm	800
Width	mm	450
Depth	mm	350
Weight	kg	47

## General

### 1.6 Technical data mod. 428 S

Nominal heat input	kW	31,1
	BTU/h	106 107
Minimum heat input	kW	13,0
	BTU/h	44 353
Maximum useful output	kW	28,0
	BTU/h	95 530
Minimum useful output	kW	11,0
	BTU/h	37530

Central heating		
Maximum temperature	°C	90
Minimum temperature	°C	35
Maximum pressure	kPa	300
	bar	3
Minimum pressure	kPa	30
	bar	0,3
Available head (in 1000 l/h)	kPa	26
	bar	0,26

Domestic hot water		
Maximum temperature	°C	55
Minimum temperature	°C	37
Maximum pressure	kPa	1 000
	bar	10
Minimum pressure	kPa	30
	bar	0,3
Flow rate		
minimum	l/min	2,5
30° rise	l/min	13,3
35° rise	l/min	11,4
40° rise	l/min	10,0

Injectors	
Natural G20	125
Butane G30	75
Propane G31	75

Gas supply pressures				
Gas		norm.	min	max
Natural G20	Pa	2 000	1 700	2 500
	mbar	20	17	25
Butane G30	Pa	2 900	2 000	3 500
	mbar	29	20	35
Propane G31	Pa	3 700	2 500	4 500
	mbar	37	25	45

Maximum pressures at the burner		
Natural G20	Pa	1 100
	mbar	11,0
Butane G30	Pa	2 680
	mbar	26,8
Propane G31	Pa	3 500
	mbar	35,0
Maximum gas rate		
Natural G20	m <sup>3</sup> /h	3,29
Butane G30	kg/h	2,45
Propane G31	kg/h	2,41

Minimum pressures at the burner		
Natural G20	Pa	140
	mbar	1,4
Butane G30	Pa	550
	mbar	5,5
Propane G31	Pa	700
	mbar	7,0
Minimum gas rate		
Natural G20	m <sup>3</sup> /h	1,37
Butane G30	kg/h	1,02
Propane G31	kg/h	1,00

G 20 p.c.i. 35,9 MJ/m<sup>3</sup>

G 30 p.c.i. 45,6 MJ/kg

G 31 p.c.i. 46,4 MJ/kg

1 mbar approximately equals 10 mm H<sub>2</sub>O

---

## General

---

<b>Electrical Data</b>		
Voltage	V~	220–240
Frequency	Hz	50
Power consumption	W	170
Protection degree		IP44
External fuse rating	A	3
Internal fuse rating	A	1,6 T

<b>Flue design</b>		
Minimum venturi pressure	mbar	– 1,4
Flue pipe diameter		
Coaxial	mm	60/100
Twin split pipes	mm	80
Roof	mm	80/120
Nominal heat flow rate*	kW	31,1
Exhaust temperature*	°C	120
Smoke production*	kg/h	80
<i>* Values refer to tests with a 1 m chimney working at the nominal heat input</i>		

<b>Other specifications</b>		
Height	mm	800
Width	mm	500
Depth	mm	350
Weight	kg	49

## General

### 1.7 Technical data mod. 424 RS

Nominal heat input	kW	26,6
	BTU/h	90 754
Minimum heat input	kW	11,0
	BTU/h	37 530
Maximum useful output	kW	24,0
	BTU/h	81 883
Minimum useful output	kW	9,3
	BTU/h	31 730

<b>Central heating</b>		
Maximum temperature	°C	90
Minimum temperature	°C	35
Maximum pressure	kPa	300
	bar	3
Minimum pressure	kPa	30
	bar	0,3
Available head (in 1000 l/h)	kPa	26
	bar	0,26

<b>Gas supply pressures</b>				
Gas		norm.	min	max
Natural G20	Pa	2 000	1 700	2 500
	mbar	20	17	25
Butane G30	Pa	2 900	2 000	3 500
	mbar	29	20	35
Propane G31	Pa	3 700	2 500	4 500
	mbar	37	25	45

<b>Maximum gas pressures at the burner</b>		
Natural G20	Pa	1 050
	mbar	10,5
Butane G30	Pa	2 680
	mbar	26,8
Propane G31	Pa	3 500
	mbar	35,0
<b>Maximum gas rate</b>		
Natural G20	m <sup>3</sup> /h	2,82
Butane G30	kg/h	2,09
Propane G31	kg/h	2,06

<b>Minimum gas pressures at the burner</b>		
Natural G20	Pa	130
	mbar	1,3
Butane G30	Pa	550
	mbar	5,5
Propane G31	Pa	700
	mbar	7,0
<b>Minimum gas rate</b>		
Natural G20	m <sup>3</sup> /h	1,16
Butane G30	kg/h	0,87
Propane G31	kg/h	0,85

<b>Injectors</b>	
Natural G20	125
Butane G30	75
Propane G31	75

G 20 p.c.i. 35,9 MJ/m<sup>3</sup>

G 30 p.c.i. 45,6 MJ/kg

G 31 p.c.i. 46,4 MJ/kg

1 mbar approximately equals 10 mm H<sub>2</sub>O

---

## General

---

<b>Electrical Data</b>		
Voltage	V~	220–240
Frequency	Hz	50
Power consumption	W	170
Protection degree		IP44
External fuse rating	A	3
Internal fuse rating	A	1,6 T

<b>Flue design</b>		
Minimum venturi pressure	mbar	–1,2
Flue pipe diameter		
Coaxial – wall	mm	60/100
Twin split pipes	mm	80
Coaxial – roof	mm	80/120
Nominal heat flow rate*	kW	26,6
Exhaust temperature*	°C	125
Smoke production*	kg/h	70
<i>* Values refer to tests with a 1 m chimney working at the nominal heat input</i>		

<b>Other specifications</b>		
Height	mm	800
Width	mm	450
Depth	mm	350
Weight	kg	43

## 1.8 Hydraulic specifications

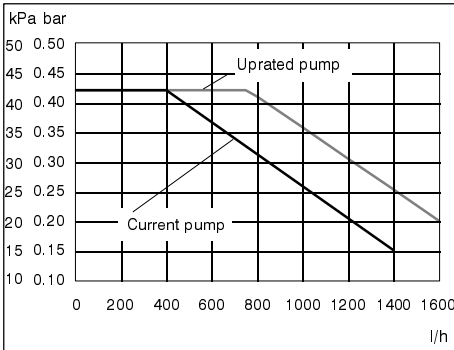

fig. 1.5

The hydraulic specifications in fig. 1.5 represent the pressure (available head of the central heating system) as a function of the flow rate.

The load loss due to the boiler has already been subtracted.

If necessary, it is possible to replace the current pump with an uprated head one (supplied separately).

The boiler is fitted with an automatic by-pass valve (26 on page 3), which acts as a protection to the primary heat exchanger.

In case of excessive reduction or total blockage of water circulation in the central heating system due to the closure of the thermostatic valves or system

component cocks, the by-pass valve ensures a minimum flow of water through the primary heat exchanger.

## 1.9 Expansion tank

The height difference between the pressure relief valve and the highest point in the system may be 7m at most.

For greater differences, increase the pre-load pressure in the expansion tank (27 on page 3) and in the system, when cold, by 0.1 bar for each additional meter.

Total capacity		8,0
Pre-load pressure	kPa	100
	bar	1,0
Available capacity		4,3
Maximum volume of water in the system *		150

tab. 1.1

\* Where conditions are:

- Average maximum temperature of the system is 80°C
- Initial temperature when filling up the system is 10°C

For systems with volumes greater than 150 l, an additional expansion tank must be provided.



This appliance must be installed by a competent person in accordance with the Gas Safety (Installation & Use) Regulations 1994.

### 2.1 Related documents

The installation of this appliance must be in accordance with the relevant requirements of the current Gas Safety (Installation & Use) Regulations, the Local Building Regulations, the current I.E.E. Wiring Regulations, the by-laws of the local water undertaking, and in Scotland, in accordance with the Building Standards (Scotland) Regulation, Health and safety document n° 635 "Electricity at work regs."

It should be in accordance also with the British Standard Codes of Practice:

### 2.2 Location of appliance

The appliance may be installed in any room or internal space, although particular attention is drawn to the requirements of the current I.E.E. Wiring Regulations, and in Scotland, the electrical provisions of the Building Regulations applicable in Scotland, with respect to the installation of the combined appliance in a room containing a bath or shower.

**Where a room – sealed appliance is installed in a room containing a bath or shower, any electrical switch or appliance control, utilising mains electricity should be so situated that it cannot be touched by a person using the bath or shower.**

The location must permit the provision of an adequate flue and termination.

For unusual locations special procedures may be necessary and BS 6798–1987 gives detailed guidance on this aspect.

A compartment used to enclose the appliance must be designed specifically for this purpose.

This appliance is not suitable for external installation.

### 2.3 Flue system

The provision for satisfactory flue termination must be made as described in BS 5440–1 1990.

The appliance must be installed so that the flue terminal is exposed to external air.

It must not be installed so that the terminal discharges into an other room or space as an out-house or lean-to. It is important that the position

of the terminal allows a free passage of air across at all times.

The terminal should be located with due regard for the damage or discoloration that might occur to building products in the vicinity.

In cold and/or humid weather water vapour may condense on leaving the flue terminal; the effect of such "steaming" must be considered.

The minimum acceptable spacing from the terminal to obstructions and ventilation openings are specified in fig. 2.1.

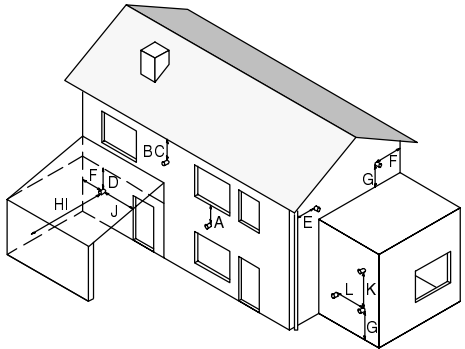

fig. 2.1

Terminal position	mm
A . Directly below a window or other opening . . . . .	300
B . Below gutters, solid pipes or drain pipes . . . . .	75
C . Below eaves . . . . .	200
D . Below balconies or car port roof . . . . .	*650
E . From vertical drain pipes and soil pipes . . . . .	75
F . From internal or external corners . . . . .	*450
G . Above ground or below balcony level . . . . .	300
H . From a surface facing a terminal . . . . .	600
I . From a terminal facing a terminal . . . . .	1 200
J . From an opening in the car port (e.g. door, window) into dwelling . . . . .	1 200
K . Vertically from a terminal in the same wall . . . . .	1 500
L . Horizontally from a terminal in the same wall 300	

\* specific manufacturer requirements

### 2.4 Gas supply

Gas meter is connected to the service pipe by the local gas region or a local gas region contractor.

If the gas supply for the boiler serves other appliances ensure that an adequate supply is available both to the boiler and the other appliance when they are in use at the same time.

---

## General requirements

---

Pipework must be of adequate size. Pipes of a smaller size than the boiler inlet connection should not be used.

Installation pipes should be fitted in accordance with BS 6891–1988 and the complete installation should be tested for soundness.

### 2.5 Air supply

The room in which the boiler is installed does not require a purpose provided air vent.

### 2.6 Ventilation

If installed in a cupboard or compartment, ventilation is also required for cooling.

Recommendations for air supply are detailed in BS 5440–2 1989.

### 2.7 Water circulation (central heating)

Detailed recommendations are given in BS 6798–1987 and BS 5449–1 1990; the following notes are given for general guidance.

#### Pipework

Copper tubing to BS EN 1057–1996 is recommended for water pipes. Jointing should be either with capillary soldered or with compression fittings.

Where possible pipes should have a gradient to ensure air is carried naturally to air release points and water flows naturally to drain taps.

Although the appliance has a built-in automatic air release valve, precautions should be taken as to ensure that the appliance heat exchanger is not a natural collecting point for air.

Except where providing useful heat, pipes should be insulated to prevent heat loss and to avoid freezing.

Particular attention should be paid to pipes passing through ventilated spaces in roofs and under floors.

#### By-pass

The appliance includes an automatic by-pass valve which protects the main heat exchanger in case of reduced or interrupted water circulation

through the heating system due to the closing of thermostatic valves or cock-type valves within the system.

The by-pass is calibrated to assure a minimum flow of 500–600 lts/hr through the main heat exchanger.

If you are installing a system that includes thermostatic radiator valves (TRV) and/or small bore (8–10 mm) it may be necessary to fit an external by-pass to facilitate correct operations of the boiler.

#### Air release points

These must be fitted at all high points where air will naturally collect and must be sited to facilitate complete filling of the system.

The appliance has an integral sealed expansion vessel to accommodate the increase of water volume when the system is heated.

It can accept up to 7 lts (1,5 gals.) of expansion water.

If the heating circuit has an unusually high water content, calculate the total expansion and add additional sealed expansion vessel with adequate capacity.

#### Mains water feed

**The boiler is designed to withstand a domestic water pressure of 10 bar.**

**Where it is likely that the mains domestic water pressure may exceed 5 bar, it is possible due to internal “water hammer” effects that the pressure within the domestic system can increase to a level in excess of the 10 bar limit.**

**If these circumstances it is therefore recommended that a 3 bar pressure reducing valve be fitted to the incoming mains water supply and a mini expansion vessel installed on the domestic circuit.**

**These devices will protect the boiler and the domestic system from damage due to excessive domestic water pressure.**

#### Filling

A method for initially filling the system and replacing water lost during servicing must be provided

---

## General requirements

---

and it must comply with local water authority regulations.

A possible method is shown in fig. 2.2.

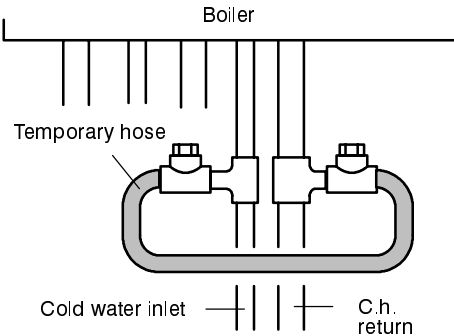

fig. 2.2

The installer should ensure that no leaks exist as frequent filling of the system could cause premature scaling of the heat exchanger.

### 2.8 Domestic water

The domestic water must be in accordance with the relevant recommendations of BS 5546–1990.

Copper tubing to BS EN 1057–1996 is recommended for water carrying pipework and must be used for pipework carrying potable water.

### 2.9 Electrical supply

**Warning, this appliance must be earthed.**

External wiring to the appliance must be carried out by a competent person and be in accordance with the current I. E. E. Regulations and local regulations which apply.

The boiler is supplied for connection to a 240 V~ 50 Hz supply. The supply must be fused at 3A.

The method of connection to the electricity supply must facilitate complete electrical isolation of the appliance by the use of a fused double pole isolator having a contact separation of at least 3 mm in all poles or alternatively, by the use of a 3A fused three pin plug and unswitched shuttered socket outlet both complying with BS 1363–1984.

The point of connection to the electricity supply must be readily accessible and adjacent to the appliance except where the appliance is installed in a bathroom this must be sited outside the bathroom.

## 3 INSTALLATION

### 3.1 Warnings

The use of gas appliances is subject to statutory control. It is essential to observe the current regulations and laws in force (see also chapter 2).

The appliance must discharge combustion products directly outside or into a suitable exhaust duct designed for this purpose.

Combustion products must be discharged using original flue kits only, since they are integral parts of the boiler.

For LPG, the appliance must also conform with the requirements of the distributors and comply with current Regulations and laws in force.

The safety relief valve must be connected to a suitable drain or discharge in a safe manner.

The electrical wiring must conform with current Regulations, in particular:

- the boiler **must** be earthed using the correct connection terminal.
- a fused spur isolation switch with a gap of at least 3 mm between the contacts (fig. 3.1) must be installed near to the boiler. Refer to the section 3.6 of this chapter for the electrical connections.

**In no circumstances may the manufacturer be held responsible if the warnings and instructions contained in this manual have not been complied with.**

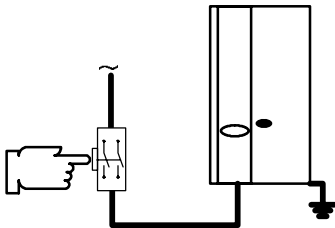

fig. 3.1

### 3.2 Precautions

For the installation proceed as follows:

- The boiler must be fixed to a strong wall (fig. 3.2).

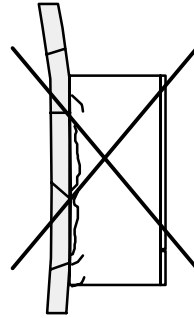
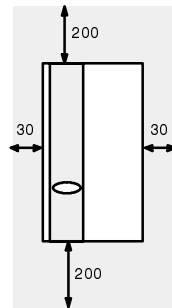

fig. 3.2

- The dimensions for the exhaust fume duct detailed in section 3.5, and the correct procedures for installing the duct, depicted in the instruction leaflet included with the flue kit, must be complied with during installation.
- To allow maintenance procedures it is necessary to leave the minimum gaps indicated in fig. 3.3.



All dimensions in mm

fig. 3.3

- When installing the boiler in a cupboard, cover or in an alcove, further than the distances defined in fig. 3.3, bear in mind that any possible obstacle in front of the boiler (the cupboard door for example) must be at such a distance as to allow a regular air flow; the upper part of the boiler must be freed from any obstacles.
- If the boiler is installed in an exposed area, cover the appliance to protect it against the elements and add some special anti-freeze (neutralised) to the central heating system.

## Installation

An optional anti-freeze kit is available to be fitted with this appliance.

- Before installing the boiler on an existing central heating system, flush it out thoroughly before fitting the boiler, so as to remove muddy deposits.
- It is advisable to equip the system with a sediment filter, or use a water-treatment product in the circulating water.

The latter option in particular, not only cleans out the system, but also has an anti-corrosive effect by promoting formation of a protective skin on metal surfaces and neutralising gases dissolved in the water.

We recommend the use of a suitable universal inhibitor to protect the central heating system from corrosion.

### 3.3 Installing the bracket

Dimensions and useful data for fitting the boiler are given on separate instructions included with the documents.

#### Precautions

Before mounting the bracket, check that the dimensions for fitting the exhaust fume duct are complied with (refer to the leaflet included with the flue kit, packed separately).

After mounting the bracket and before mounting the boiler, make sure the gas supply system is not leaking.

### 3.4 Mounting the boiler

- 1 Take the protective caps off the boiler pipework.
- 2 Thoroughly clean the taps.
- 3 Mount the boiler on its bracket.
- 4 Connect the pipework using the original seals supplied with the taps. You are recommended to tighten up the water and gas joints well.
- 5 Connect the pressure relief valve's outlet to a drain (8 in fig. 3.4).

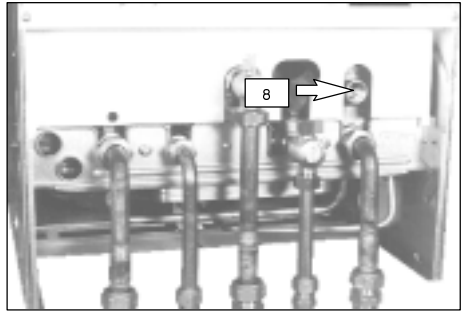

fig. 3.4 (bottom view of the boiler)

### 3.5 Fitting the balanced flue system

Refer to the leaflet included in the chosen kit, packed separately.

The following kits for connecting the boiler to the flue are available:

- Flue exhaust pipes towards the wall and possible co-axial extensions  $\varnothing$  60/100 mm

It allows the flue to be fitted on any side of the boiler and it can be **shortened to a minimum** of 0.5 m. Use of extensions allows the exhaust fume duct to be lengthened. For all models the greatest total length is 2,65.

- Vertical flanged extension  $\varnothing$  60/100 mm

This Kit is an accessory that allows use of a section of vertical ducting from the boiler.

**In fitting, only one kit of this type can be used.**

- Connection for co-axial flue  $\varnothing$  60/100 mm

This is an accessory that allows the fumes to be discharged through co-axial flues.

- Additional co-axial 90° or 45° elbow  $\varnothing$  60/100 mm

## Installation

Each additional 90° elbow  $\varnothing$  60/100 mm reduces the greatest length of the flue system by 1 m, whilst those of 45° reduce it by 0.5 m.

- Twin split pipes kit and possible extensions  $\varnothing$  80 mm

This Kit is an accessory that allows separation of the air supply pipe from the pipe that discharges the exhaust gasses in the flue.

Additional 90° or 45° elbow  $\varnothing$  80 mm are available.

Each additional 90° elbow  $\varnothing$  80 mm reduces the maximum length of the duct by 1 m, whilst those of 45° reduce it by 0.5 m.

- Co-axial discharge to the roof and possible extensions  $\varnothing$  80/120 mm

It allows venting of fumes directly to the roof.

**The greatest total height is 5 m.**

Please, see boiler accessories leaflet for full details or contact Biasi UK Technical Helpline.

### 3.6 Electrical connections

#### Connection to the electricity supply

To gain access to the supply terminal block unscrew the screws A (fig. 3.5) and lower the control panel.

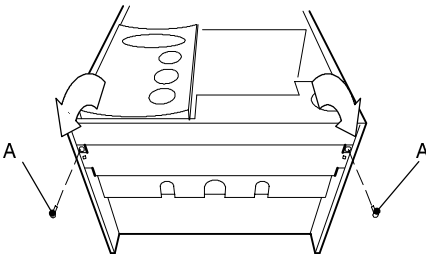

fig. 3.5

Remove the terminal block cover B (fig. 3.6).

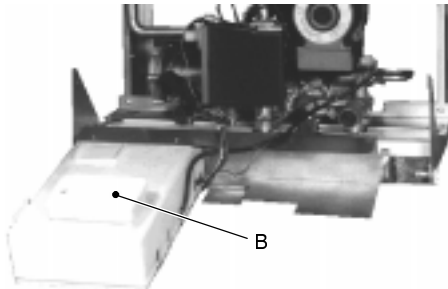

fig. 3.6

The cable or wire for the appliance's electricity supply must be of not less than 0.75 mm<sup>2</sup> gauge but must adhere to the current Regulations.

The cable must be long enough to permit the lowering of the control panel.

- 1 Connect the electrical supply cable coming from the fused spur or plug to the supply connector for the boiler keeping the same connections for the live (brown wire) and the neutral (blue wire).

External 3 A fuse or fused plug with same current rating is recommended.

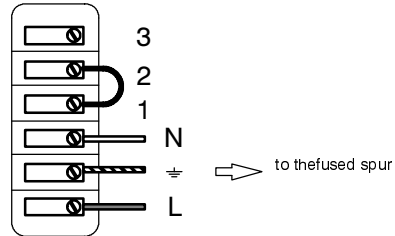

fig. 3.7

Do not connect live wires to terminals to which the room thermostat / frostat must be connected.

- 2 Connect the earth wire (yellow/green).

#### Connection of a room thermostat

The room thermostat must be connected to the terminal block situated next to the control panel.

**When connecting any type of room thermostat, the jumper present between 1 and 2 must be removed.**

**Take care not to connect live wires to terminals 1 and 2.**

Connect the room thermostat as shown in one of the two following diagrams (fig. 3.8 or fig. 3.9).

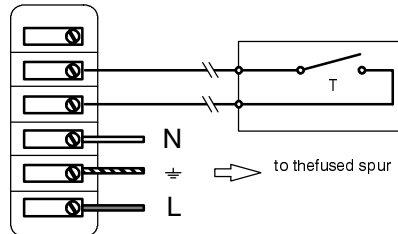

fig. 3.8 Two-wire thermostat. (240 V only).

## Installation

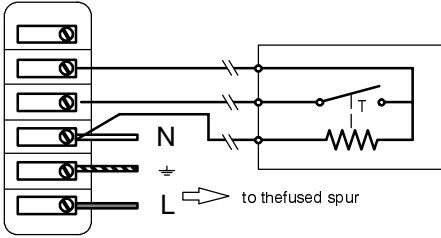

fig. 3.9 Two-wire thermostat with delay resistor (240V only)

### 3.7 Frost protection (froststat)

The froststat must be connected to the terminal block situated next to the control panel between terminals 2 and 3.

**Take care not to connect live wires to terminals 2 and 3.**

Connect the froststat as shown in the following diagram (fig. 3.10).

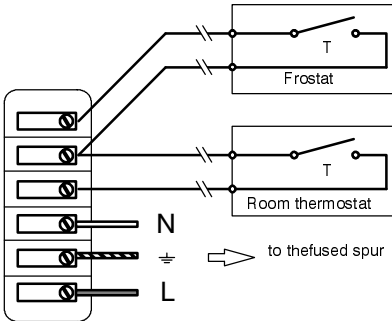
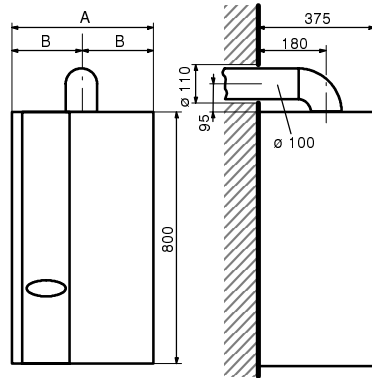

fig. 3.10 Room thermostat and froststat

### 3.8 Overall dimensions



A = 450 for mod. 424  
= 500 for mod. 428

B = 225 for mod. 424  
= 250 for mod. 428

fig. 3.11

### 3.9 Joints

Functions	Pipe sizes (mm o.d.)
Gas	ø 22
Central heating return	ø 22
Central heating flow	ø 22
Domestic cold water inlet*	ø 15
Domestic hot water outlet*	ø 15
Pressure relief valve	ø 15 connector
* not present on c.h. only boilers	

tab. 3.1

The positions of the joints are given on separate instructions included with the documents.

## 4 COMMISSIONING

### 4.1 Electrical installation

Preliminary electrical system checks to ensure electrical safety shall be carried out by a competent person. I.e. polarity, earth continuity, resistance to earth and short circuit.

If a fault has occurred on appliance the fault finding procedure should be followed as specified under the servicing section.

### 4.2 Gas supply installation

Inspect the entire installation including the gas meter, test for soundness and purge, all as described in BS 6891–1988;

Open the gas cock (30 in fig. 4.1) on the appliance and check the gas connector on the appliance for leaks.

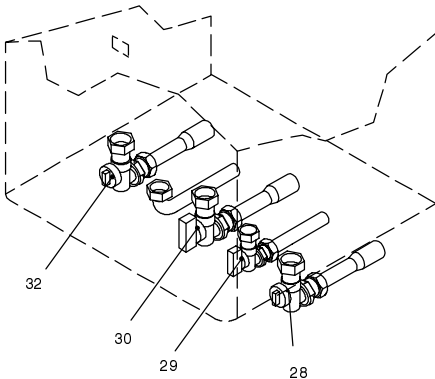

fig. 4.1

### 4.3 Filling the D.H.W. system

Close all hot water draw-off taps.

Open the cold water inlet cock 29 (fig. 4.1).

Slowly open each draw-off tap and close it only when clear water, free of bubbles, flows out.

### 4.4 Initial filling of the system

Connect the filling loop as demonstrated in fig. 2.2 of this manual and open the central heating flow and return cocks.

Remove the front panel of the case (see the section *Access to and emptying the hydraulic circuits* in the service manual).

Unscrew the cap on the automatic air release valve indicated in fig. 4.2 one full turn and leave open permanently;

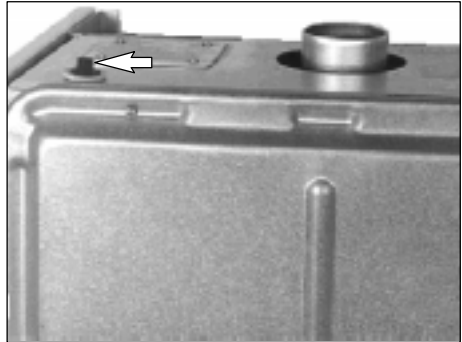

fig. 4.2

Switch off the central heating operation by means of the time switch or the room thermostat.

Switch on the boiler rotating the function switch 39 for central heating operation (fig. 4.3).

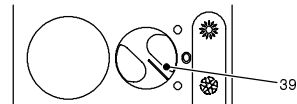

fig. 4.3

Gradually open the valves of the filling loop and watch the main circuit pressure display 44 until the central green light comes on (fig. 4.4).

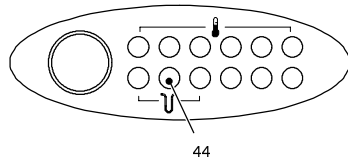

fig. 4.4

Open each air release tap starting with the lower point and close it only when clear water, free of bubbles, flows out;



## Commissioning

Purge the air from the pump by unscrewing the pump plug indicated (fig. 4.5); release the pump by turning the rotor;

close the pump plug and continue filling the system.

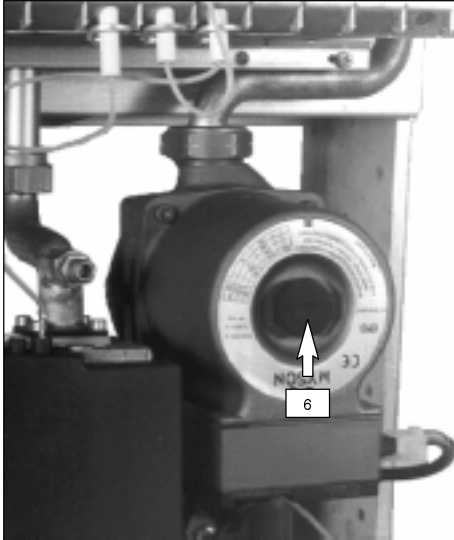

fig. 4.5

Close all air release valves on central heating system.

inspect the system for water soundness and remedy any leaks discovered.

**When the installation and filling are completed turn on the central heating system and run it until the temperature has reached the boiler operating temperature. The system must then be immediately flushed through.**

**The flushing procedure must be in line with BS7593: 1992 *Treatment of Water in Domestic Hot Water Central Heating Systems*.**

**This procedure must be repeated twice more.**

During this operation we highly recommend the use of a central heating flushing detergent in the quantities as specified by the appropriate manufacturer, whose function it is to dissolve any foreign matter which may be in the system

The above operation could save the invalidation of your boilers guarantee and will also pre-

**vent problems which you may experience in the future if an inhibitor is not used.**

### 4.5 Lighting the boiler

If external controls are fitted (e. g. Timeclock, room thermostat) ensure they "call for heat".

Switch on the mains electricity and turn the function switch 39 as indicated in fig. 4.6.

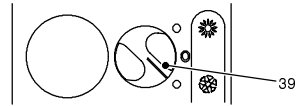

fig. 4.6

The temperature 35 and pressure 44 lights should be illuminated.

The boiler will now go through an ignition sequence and the burner will light.

If during the ignition attempt period the boiler fails to light, the full sequence control p.c.b. will go to lockout and the shut-down warning light 45 will appear (fig. 4.7).

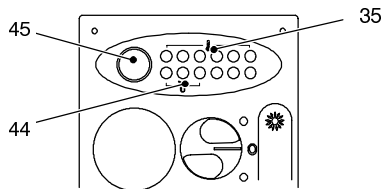

fig. 4.7

To reset the boiler depress the reset push button 45.

### 4.6 Checking the gas pressure at the burner

This boiler has been tested to the highest quality controls standards.

The maximum and minimum gas pressures are already pre-set during this quality control process.

It is therefore not normally necessary to undertake further adjustments however, a full explanation of pressure testing procedure is given below and the adjustment procedure is

## Commissioning

given in the service manual, *Gas Valve* section, if these operations are ever required.

Remove the front panel of the case and lower the control panel.

Loosen the screw of the pressure test point 9 (fig. 4.8) for measuring outlet pressure at the gas valve outlet and fit a pressure gauge using a hose;

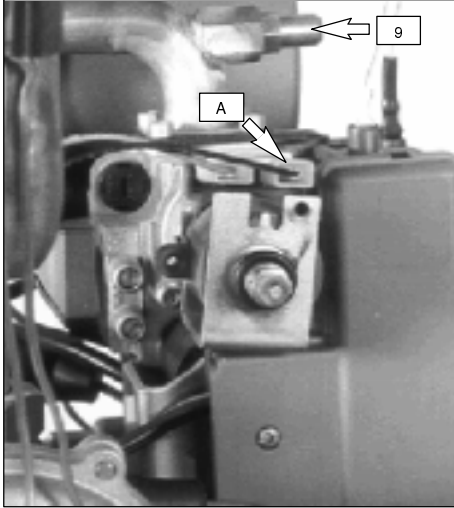

fig. 4.8 left view of the gas valve

Switch on the boiler.

On the combined boilers open the hot water tap fully.

Set the d.h.w. temperature adjustment and the c.h. temperature adjustment to their maximum position.

Check the maximum gas pressure and compare the value on the manometer with the values indicated on the section *General – Technical data*

Check the maximum gas flow at the gas meter and compare with the values indicated on the section *General – Technical data*

turn off the electricity supply;

disconnect the gas modulator removing the connector A (fig. 4.8).

Switch on the boiler.

check the minimum gas pressure and compare the value on the manometer with the values indicated on the section *General – Technical data*

switch off the appliance and re-connect the line to the gas modulator;

close the domestic hot water valve.

### 4.7 Checking the flue system

The flue system should be visually checked for soundness. Check all clamps, gaskets and fixings are secure and tight.

To check the exhaust gas, remove the screw indicated and connect the analyzer to the exhaust gas sampling point (fig. 4.9).

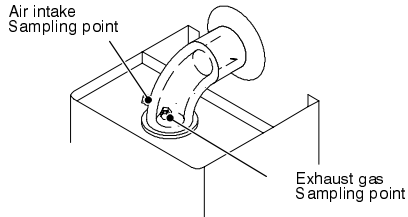

fig. 4.9

### 4.8 Checking the ignition device

With the burner on high flame close the gas valve. about 10 seconds after, the shut-down warning light must appear.

To reset the boiler depress the reset push button 45 (fig. 4.10)

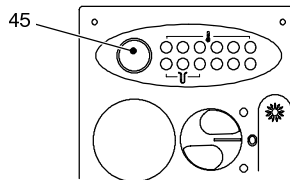

fig. 4.10

### 4.9 Adjusting the burner ignition

- 1 Turn off the boiler by means of fused spur isolation switch provided with the appliance.
- 2 Make sure that the function switch (39) is set to the position in fig. 4.11 and that the room thermostat, if fitted, is set to “call for heat”.

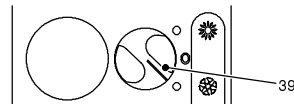

fig. 4.11

- 3 Unscrew the gas valve's outlet pressure test point (9 in fig. 4.8) and connect a pressure gauge.

## Commissioning

- 4 Loosen the screws indicated in fig. 4.12 and remove the cover of the control panel.

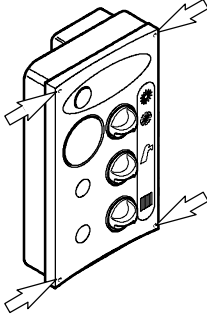

fig. 4.12

- 5 Turn on the boiler.  
6 Check that the boiler lights up uniformly and adjust the flame height, if necessary.

To adjust the ignition, set dip-switch "3" (fig. 4.13) to the OFF position and adjust potentiometer marked "ACC" with a screwdriver until correct lighting up is obtained (refer to tab. 4.1). Having finished this procedure, reset dip-switch "3" to the ON position.

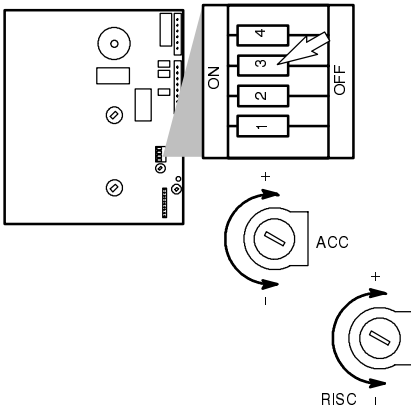

fig. 4.13

### Ignition pressure

Natural G20	Pa	600
	mbar	6,0
Butane G30	Pa	1 200
	mbar	12,0
Propane G31	Pa	1 300
	mbar	13,0

tab. 4.1

### 4.10 Adjustment of useful central heating output

Use a suitable screwdriver to turn the adjustment potentiometer marked "RISC" (fig. 4.13). Rotating the potentiometer anti-clockwise reduces the maximum supply current to the gas modulator device, and thus reduces the gas pressure to the burner.

Set the gas pressure according to the useful output chosen and adjust the gas flow rate according to fig. 4.14, fig. 4.15, and fig. 4.16.

Shut the cover of the control circuit board.

**Close the pressure test points well** and re-mount the case properly.

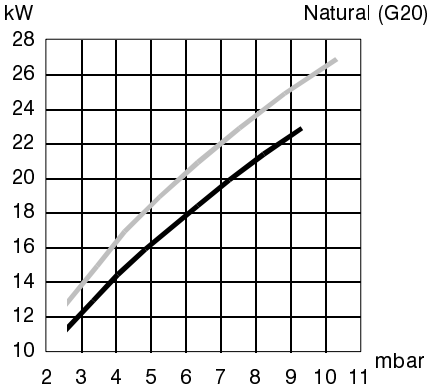

424S 424SR  
 428S

fig. 4.14

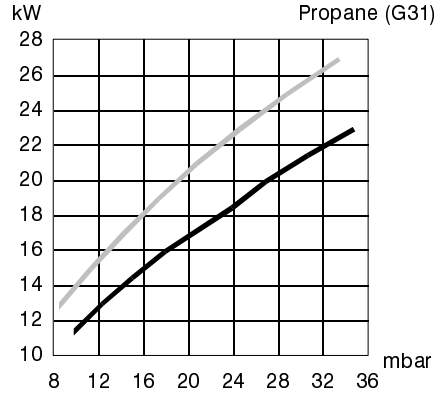

424S 424SR  
 428S

fig. 4.16

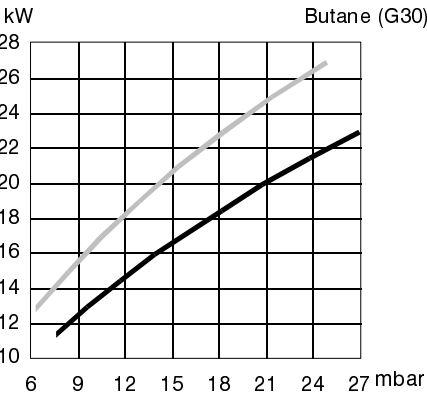

424S – 424SR  
 428S

fig. 4.15

## 4.11 Instructing the user

Hand over the *User's instructions* supplied with the appliance and explain how to use the unit in both c.h. and d.h.w. modes;

take the User step by step through the lighting instructions;

show the User how to switch off the appliance quickly and indicate the position of the electric supply isolator;

explain the proper use and adjustment of all system controls; this will ensure the greatest possible fuel economy;

explain the function and use of the function switch;

explain and demonstrate the function of time and temperature controls (if fitted);

explain how to turn off the appliance for both short and long periods and advise on the precautions necessary to prevent damage should the appliance be inoperative when freezing conditions may occur;

finally, advise the User that, for continued safe and efficient operation, the appliance must be serviced by a competent person at least once a year.

## 5 GAS CONVERSION

### 5.1 Warnings

Procedures to adapt the boiler to the type of gas available **must be carried out** by a competent and responsible person.

Components used to adapt it to the type of gas available must be genuine parts only.

More detailed instructions, relating to the procedures for adapting the boiler to the type of gas available and subsequent calibration described below, are presented in the instruction leaflet for the conversion kit.

### 5.2 Procedures

- 1 Check that the gas cock (30 on page 3) fitted under the boiler is turned off and the appliance is not live.
- 2 Remove the front and left-hand side panels as shown in chapter *maintenance*, section 6.2 of this manual.
- 3 Lower the control panel.
- 4 Remove the cover of the sealed chamber.
- 5 Take the front panel of the combustion chamber off and remove the burner (16 on page 3).
- 6 Carry out the conversion for the type of gas, replacing the burner injectors (16 on page 3) correctly.
- 7 Re-assemble the burner (16 on page 3), the front panel of the combustion chamber and the cover of the sealed chamber.
- 8 Loosen the screws indicated in fig. 5.1 and remove the cover of the control panel.

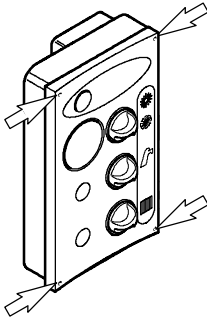

fig. 5.1

- 9 set correctly the dip-switch "2" (fig. 5.2) in accordance with the following table.

Gas supply	Position of dip-switch n. 2
Natural gas	On
L.P.G.	Off

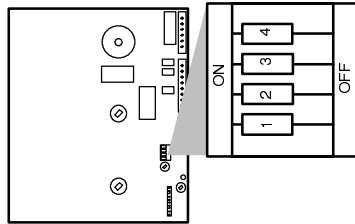

fig. 5.2

- 10 Calibrate the gas valve according to the instructions given in the leaflet included with the conversion kit.
- 11 Replace the the control circuit board cover, the front panel and the left-hand side panel of the case.
- 12 Stick a label indicating the type of gas, and the pressure level to which the appliance has been set, on the lower protection plate. The self-adhesive label is included with the conversion kit.

## 6 MAINTENANCE

### 6.1 Warnings

The procedures detailed in this chapter **must be carried out only by a professionally qualified person**. Thus you are advised to contact an Authorised Service Centre.

For efficient and continuous operation of the boiler you are advised to have, at least once a year, maintenance and cleaning done by an Authorised Service Centre engineer.

**Isolate the appliance from the electricity supply** at the fused spur sitch or plug fitted with the appliance and **turn off the gas cock**, before carrying out any procedures, whatsoever, for cleaning, maintenance, opening or dismantling boiler panels.

### 6.2 Dismantling the external panels

#### Front panel

- 1 Loosen the two screws "A". Bring the base of the panel far from the boiler and lift it, freeing it from the top hooks (fig. 6.1)

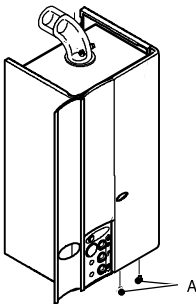

fig. 6.1

#### Side panels and lower protection plate

- 2 Loose the two screws "B" (fig. 6.2). Bring the base of the panels far from the boiler and lift them freeing from the side hooks.
- 3 Completely unscrew the screws "B" (fig. 6.2) and remove the lower protection plate.

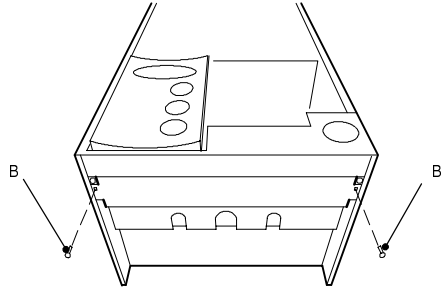

fig. 6.2

### 6.3 Emptying the domestic hot water system (Combination boilers only)

- 1 Turn off the dhw inlet cock 29 (fig. 6.3) and turn on the "utilities" cocks.

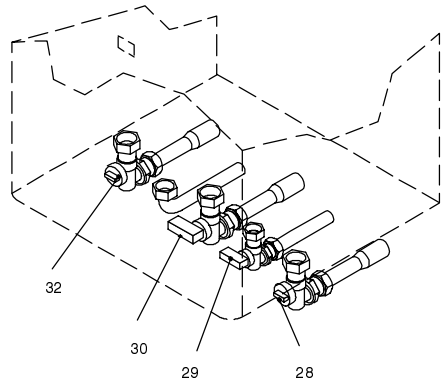

fig. 6.3

### 6.4 Emptying the central heating system

- 1 Turn off the c.h. cocks (32, 28 in fig. 6.3).
- 2 Turn on the central heating drain cock (12 in fig. 6.4).

---

## Maintenance

---

- 3 To facilitate the downflow of water, remove the front panel, also remove the sealed chamber lid and loosen the nut of the automatic air bleed valve.

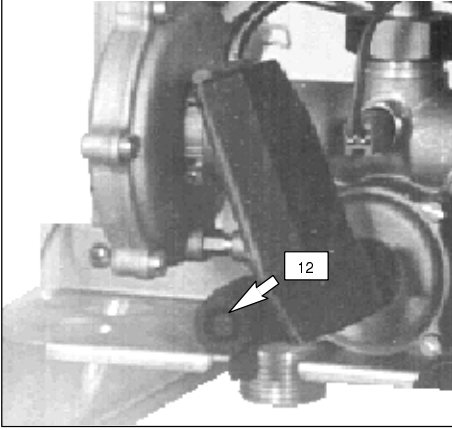

fig. 6.4

- 4 Tight it again once the emptying has been completed.

### **6.5** Cleaning the primary heat exchanger

Take off the front of the case, then the cover of the sealed chamber and the front panel of the combustion chamber.

If you notice dirt on the fins of the primary heat exchanger (19 on page 3), cover the sloping sur-

faces of the burner (16 on page 3) entirely in a protective layer (sheets of newspaper or similar). Brush out the primary heat exchanger (19 on page 3) with a bristle paintbrush.

### **6.6** Checking the pressurisation in the expansion tank

Empty the central heating system as described in section 6.4 of this chapter and check that the pressure in the expansion tank is not less than 1 bar.

If the pressure should be lower, take steps to correct the pressure level.

### **6.7** Cleaning the burner

The sloping and multi-gas type burner (16 on page 3) does not need special maintenance, but it is sufficient to dust it with a bristle paintbrush.

### **6.8** Checking the exhaust duct

Have the following checks carried out periodically (at least once a year)

integrity of the exhaust fume duct  
air duct

cleaning of the Venturi device

efficiency of the exhaust control device.

For all the above maintenance operations it is advisable to call an approved Service Engineer.



17962.0680.1 9809 (8A4)

**BIASI U.K Ltd**  
Unit 32/33, Planetary Road  
Industrial Estate, Neachelles Lane  
Willenhall, Wolverhampton WV13 3XB